

Lampada o composizione di lampade a sospensione dal disegno semplice ed essenziale, realizzate per fornire una Luce diretta continua e uniforme nel rispetto del più elevato confort visivo. Il corpo è realizzato con un profilo di alluminio, un diffusore in policarbonato opale e cavo di alimentazione coassiale.

Il sistema di aggancio consente di ruotare il profilo e orientare la luce nella direzione voluta. Questo permette di utilizzare la sospensione anche come luce indiretta.

Disponibile in diverse lunghezze e finiture.

I rosoni con alimentatori sono da ordinare separatamente in base alla tipologia della composizione scelta (pg.110).

*Lamp or composition of suspension lamps with a simple and essential design, made to provide continuous and uniform direct light in compliance with the highest visual comfort.*

*The body is made with an aluminum profile, an opal polycarbonate diffuser and coaxial power cable. The coupling system allows you to rotate the profile and direct the light in the desired direction. This allows the suspension to be used also as indirect light. Available in different lengths and finishes. The ceiling roses with power supplies are to be ordered separately according to the type of composition chosen (pg.110).*

*Lampe ou composition de lampes à suspension au design simple et essentiel, conçue pour fournir une lumière directe continue et uniforme dans le respect du plus grand confort visuel.*

*Le corps est composé d'un profilé en aluminium, d'un diffuseur en polycarbonate opale et d'un câble d'alimentation coaxial.*

*Le système de couplage vous permet de faire pivoter le profilé et de diriger la lumière dans la direction souhaitée. Cela permet à la suspension d'être utilisée également comme lumière indirecte. Disponible en différentes longueurs et finitions.*

*Les rosaces avec alimentations sont à commander séparément selon le type de composition choisi (page.110).*

*Lámpara o composición de lámparas de suspensión con un diseño sencillo y esencial, realizada para proporcionar una luz directa continua y uniforme cumpliendo con el máximo confort visual. El cuerpo está realizado con perfil de aluminio, difusor de policarbonato opal y cable de alimentación coaxial.*

*El sistema de acoplamiento le permite girar el perfil y dirigir la luz en la dirección deseada. Esto permite que la suspensión se utilice también como luz indirecta. Disponible en diferentes longitudes y acabados. Los florones con alimentadores deben pedirse por separado según el tipo de composición elegida (pág.110).*

*Lampe oder Zusammenstellung von Pendelleuchten mit einem einfachen und essentiellen Design, das ein kontinuierliches und gleichmäßiges direktes Licht bei höchstem Sehkomfort bietet.*

*Der Körper besteht aus einem Aluminiumprofil, einem opalen Polycarbonat-Diffusor und einem koaxialen Stromkabel.*

*Das Kopplungssystem ermöglicht es Ihnen, das Profil zu drehen und das Licht in die gewünschte Richtung zu lenken. Dadurch kann die Pendelleuchte auch als indirektes Licht verwendet werden. Erhältlich in verschiedenen Längen und Ausführungen.*

*Die Deckenrosetten mit Netzteil sind je nach gewählter Zusammenstellung separat zu bestellen (Seite.110).*

*Лампа или композиция из подвесных ламп с простой и простой конструкцией, обеспечивающей непрерывный и равномерный прямой свет с соблюдением высочайшего визуального комфорта. Корпус выполнен из алюминиевого профиля, диффузора из опалового поликарбоната и коаксиального кабеля питания. Система сцепления позволяет вращать профиль и направлять свет в нужном направлении. Это позволяет использовать подвеску также в качестве непрямого света. Доступны разной длины и отделки.*

*Потолочные розетки с блоками питания заказываются отдельно в соответствии с выбранной композицией (стр.110).*

# Lancia system





**1539**

- .01** Bianco - White
- .02** Nero - Black
- .85** Verniciato argento - Painted silver finishing
- .86** Verniciato oro - Painted gold finishing
- .87** Verniciato rame - Painted copper finishing
- .88** Verniciato bronzo - Painted bronze finishing

Color temperature	Light sources	lm
<b>/W</b> 4000K	LED 27W CRI>90	3390lm
<b>/WW</b> 3000K	LED 27W CRI>90	3030lm
<b>/XW</b> 2700K	LED 27W CRI>90	2835lm

1,10 Kg

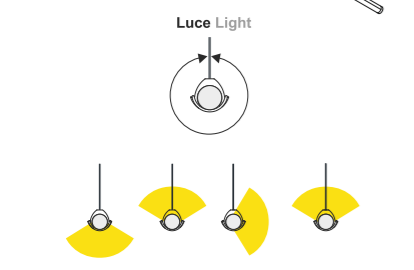
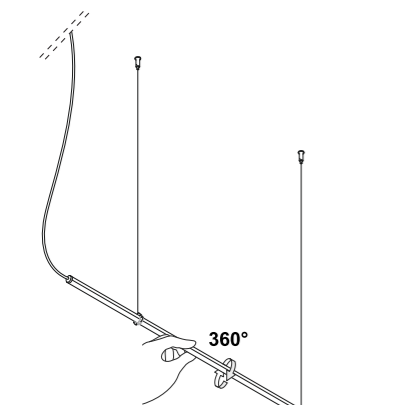
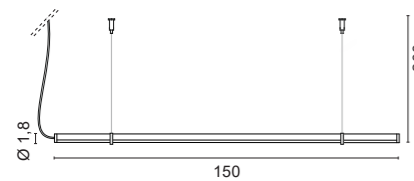

**CUSTOM SIZE - Tabella lunghezze disponibili a richiesta - Table of available lengths on request.**

cm.	watt	2700K (XW)	lm	3000K (WW)	lm	4000K (W)	lm
102	18W	A1539. * /100/XW	1890	A1539. * /100/WW	2020	A1539. * /100/W	2260
127	22,5W	A1539. * /125/XW	2362	A1539. * /125/WW	2525	A1539. * /125/W	2825
152	27W	1539. * /XW	2835	1539. * /WW	3030	1539. * /W	3390
177	31,5W	A1539. * /175/XW	3307	A1539. * /175/WW	3535	A1539. * /175/W	3955
202	36W	A1539. * /200/XW	3780	A1539. * /200/WW	4040	A1539. * /200/W	4520
227	40,5W	A1539. * /225/XW	4252	A1539. * /225/WW	4545	A1539. * /225/W	5085
252	45W	A1539. * /250/XW	4725	A1539. * /250/WW	5050	A1539. * /250/W	5650
277	49,5W	A1539. * /275/XW	5197	A1539. * /275/WW	5555	A1539. * /275/W	6215
302	54W	A1539. * /300/XW	5670	A1539. * /300/WW	6060	A1539. * /300/W	6780

\* Codice finitura: - Finishes codes: **.01 .02 .85 .86 .87 .88**

Codici finiture - Finishes codes

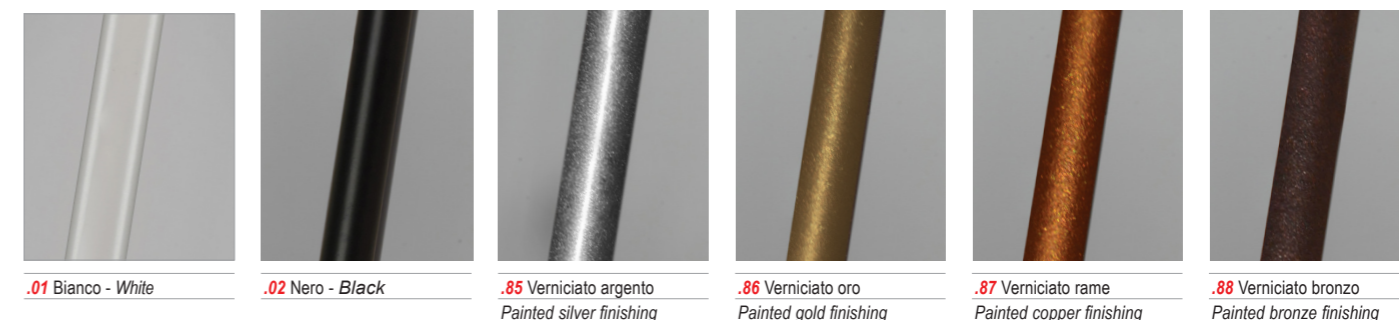

**.01** Bianco - White    **.02** Nero - Black    **.85** Verniciato argento - Painted silver finishing    **.86** Verniciato oro - Painted gold finishing    **.87** Verniciato rame - Painted copper finishing    **.88** Verniciato bronzo - Painted bronze finishing

**design P. Pepere - 2021**

Sistema di lampade dal disegno semplice ed essenziale unite da cavo coassiale.

Il corpo è realizzato con un profilo di alluminio, un diffusore in policarbonato opale e cavo di alimentazione coassiale.

Il sistema di aggancio consente di ruotare il profilo e orientare la Luce nella direzione voluta. Questo permette di utilizzare la sospensione anche come Luce indiretta.

Il kit di fissaggio tra lampade e le clip di ancoraggio a soffitto sono da ordinare separatamente.

I rosoni con alimentatori sono da ordinare separatamente in base alla tipologia della composizione scelta (pg.110).

*System of lamps with a simple and essential design joined by coaxial cable.*

*The body is made with an aluminum profile, an opal polycarbonate diffuser and coaxial power cable.*

*The coupling system allows you to rotate the profile and orient the light in the desired direction. This allows the suspension to be used also as indirect light. The lamp fixing kit and the ceiling anchoring clips must be ordered separately. The ceiling roses with power supplies are to be ordered separately according to the type of composition chosen (pg.110).*

*Système de lampes au design simple et essentiel reliées par câble coaxial. Le corps est composé d'un profilé en aluminium, d'un diffuseur en polycarbonate opale et d'un câble d'alimentation coaxial. Le système de couplage permet de faire pivoter le profilé et d'orienter la lumière dans la direction souhaitée. Cela permet à la suspension d'être utilisée également comme lumière indirecte.*

*Le kit de fixation de la lampe et les clips d'ancrage au plafond sont à commander séparément.*

*Les rosaces avec alimentations sont à commander séparément selon le type de composition choisi (page.110).*

*Sistema de lámparas de diseño sencillo y esencial unidas por cable coaxial. El cuerpo está realizado con perfil de aluminio, difusor de policarbonato opal y cable de alimentación coaxial.*

*El sistema de acoplamiento permite rotar el perfil y orientar la luz en la dirección deseada. Esto permite que la suspensión se utilice también como luz indirecta.*

*El kit de fijación de la lámpara y los clips de fijación al techo deben pedirse por separado.*

*Los florones con alimentadores deben pedirse por separado según el tipo de composición elegida (pág.110).*

*Lampensystem mit einfachem und essentiell Design, verbunden durch Koaxialkabel.*

*Der Körper besteht aus einem Aluminiumprofil, einem opalen Polycarbonat-Diffusor und einem koaxialen Stromkabel.*

*Das Kopplungssystem ermöglicht es Ihnen, das Profil zu drehen und das Licht in die gewünschte Richtung auszurichten. Dadurch kann die Pendelleuchte auch als indirektes Licht verwendet werden.*

*Das Lampenbefestigungsset und die Deckenbefestigungsclips sind separat zu bestellen.*

*Die Deckenrosetten mit Netzteil sind je nach gewählter Zusammenstellung separat zu bestellen (Seite.110).*

*Система светильников простой и строгой конструкции, соединенных коаксиальным кабелем.*

*Корпус выполнен из алюминиевого профиля, диффузора из опалового поликарбоната и коаксиального кабеля питания.*

*Система сцепления позволяет вращать профиль и ориентировать свет в нужном направлении. Это позволяет использовать подвеску также в качестве непрямого света. Комплект для крепления лампы и зажимы для крепления к потолку заказываются отдельно.*

*Потолочные розетки с блоками питания заказываются отдельно в соответствии с выбранной композицией (стр.110).*

# Multi Lancia system



**1670**

- .01** Bianco - White
- .02** Nero - Black

**2x200cm**  
 Kit di fissaggio a sospensione fornito con la lampada.  
 Suspension fixing kit supplied with the lamp.

Color temperature	Light sources	lm
<b>/W</b> 4000K	LED 72W CRI>90	9040lm
<b>/WW</b> 3000K	LED 72W CRI>90	8080lm
<b>/XW</b> 2700K	LED 72W CRI>90	7560lm



2,80 Kg

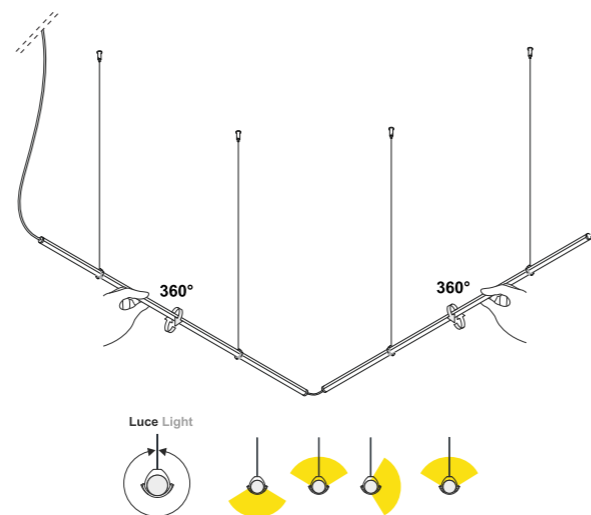
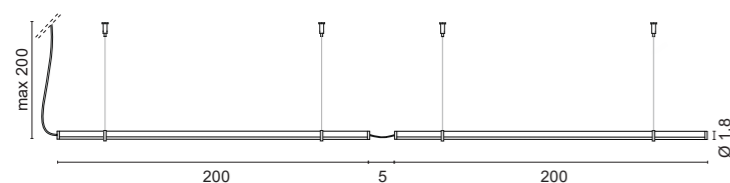

Esempio di installazione con 1 art. **0092** + 1 art. **1670**.  
 Example of installation with 1 art **0092** + 1 art **1670**.

**1671**

- .01** Bianco - White
- .02** Nero - Black

**4x100cm**  
 Kit di fissaggio a sospensione fornito con la lampada.  
 Suspension fixing kit supplied with the lamp.

Color temperature	Light sources	lm
<b>/W</b> 4000K	LED 72W CRI>90	9040lm
<b>/WW</b> 3000K	LED 72W CRI>90	8080lm
<b>/XW</b> 2700K	LED 72W CRI>90	7560lm



2,80 Kg

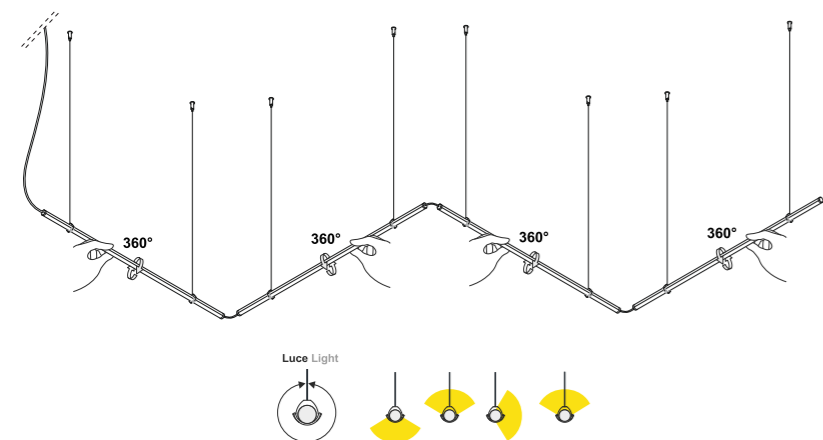
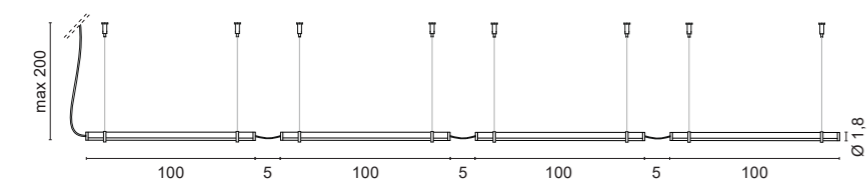

Esempio di installazione con 8 art. **0093** + 1 art. **1671**.  
 Example of installation with 8 art **0093** + 1 art **1671**.

Optional  
 Accessori - Accessories

**0092**

Kit di fissaggio tra lampade.  
 Fixing kit between lamp.

- .00** Trasparente - Clear

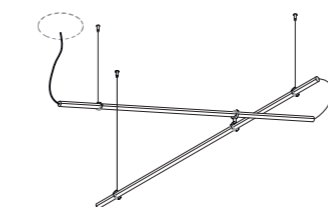

Esempio di installazione  
 con 1 art. **0092** + 1 art. **1670**.  
 Example of installation  
 with 1 art **0092** + 1 art **1670**.

**0093**

Clip di fissaggio a soffitto.  
 Ceiling fixing clip

- .00** Trasparente - Clear

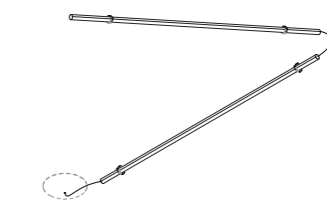
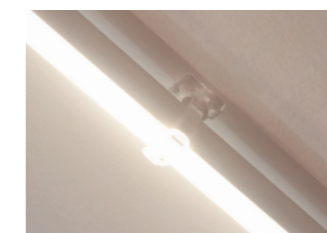

Esempio di installazione  
 con 4 art. **0093** + 1 art. **1670**.  
 Example of installation  
 with 4 art **0093** + 1 art **1670**.

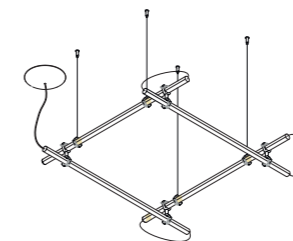

Esempio di installazione  
 con 4 art. **0092** + 1 art. **1671**.  
 Example of installation  
 with 4 art **0092** + 1 art **1671**.

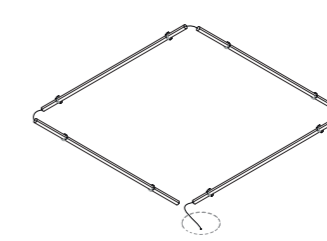

Esempio di installazione  
 con 8 art. **0093** + 1 art. **1671**.  
 Example of installation  
 with 8 art **0093** + 1 art **1671**.

Codici finiture - Finishes codes



**.01** Bianco - White



**.02** Nero - Black

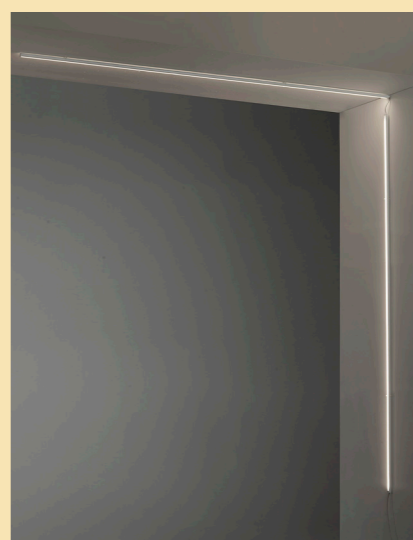

Lampade da Tavolo e Terra realizzate in alluminio verniciato con diffusore in policarbonato opalino.

Lancia, oltre ad illuminare, riesce a creare gradevoli effetti luminosi grazie alla rotazione dell'elemento luminoso ed alla possibilità di dimmerazione.

La collezione Lancia si completa con le versioni a parete e a soffitto (pg.300) e a sospensione (pg.98).

*Table and floor lamps made of painted aluminum with opal polycarbonate diffuser.*

*Besides to illuminate, Lancia manages to create pleasant lighting effects thanks to the rotation on the axis of the light element and the possibility of dimming.*

*The Lancia collection is completed with the wall (pg.300), ceiling (pg.300) and suspended (pg.98) applications.*

*Lampes de table et lampadaires en aluminium peint avec diffuseur en polycarbonate opale.*

*En plus de l'éclairage, Lancia parvient à créer des effets lumineux agréables grâce à la rotation de l'élément lumineux et à la possibilité de gradation.*

*La collection Lancia est complétée par les versions murale (p.300), plafonnier (p.300) et suspendue (p.98).*

*Lámparas de mesa y pie fabricadas en aluminio pintado con difusor de policarbonato opal.*

*Además de la iluminación, Lancia consigue crear efectos luminosos agradables gracias a la rotación del elemento luminoso y la posibilidad de atenuación.*

*La colección Lancia se completa con las versiones de pared (pág.300), techo (pág.300) y suspensión (pág.98).*

*Tisch- und Stehleuchten aus lackiertem Aluminium mit opalem Polycarbonat-Diffusor. Neben der Beleuchtung schafft Lancia dank der Drehung des Lichtelements und der Möglichkeit zum Dimmen angenehme Lichteffekte.*

*Die Lancia-Kollektion wird durch die Versionen Wand (S.300), Decke (S.300) und Pendel (S.98) vervollständigt.*

*Настольная и напольная лампы, выполненные из окрашенного алюминия с диффузором из матового поликарбоната.*

*Lancia не только освещает, но и создает приятные глазу эффекты, благодаря возможности поворачивать и диммировать светильник.*

*В коллекции Lancia есть также настенные (стр.300), потолочные (стр.300) и подвесные (стр.98) модели.*

# Lancia

design P. Pepere - 2015

# Bi Lancia

design P. Pepere - 2020

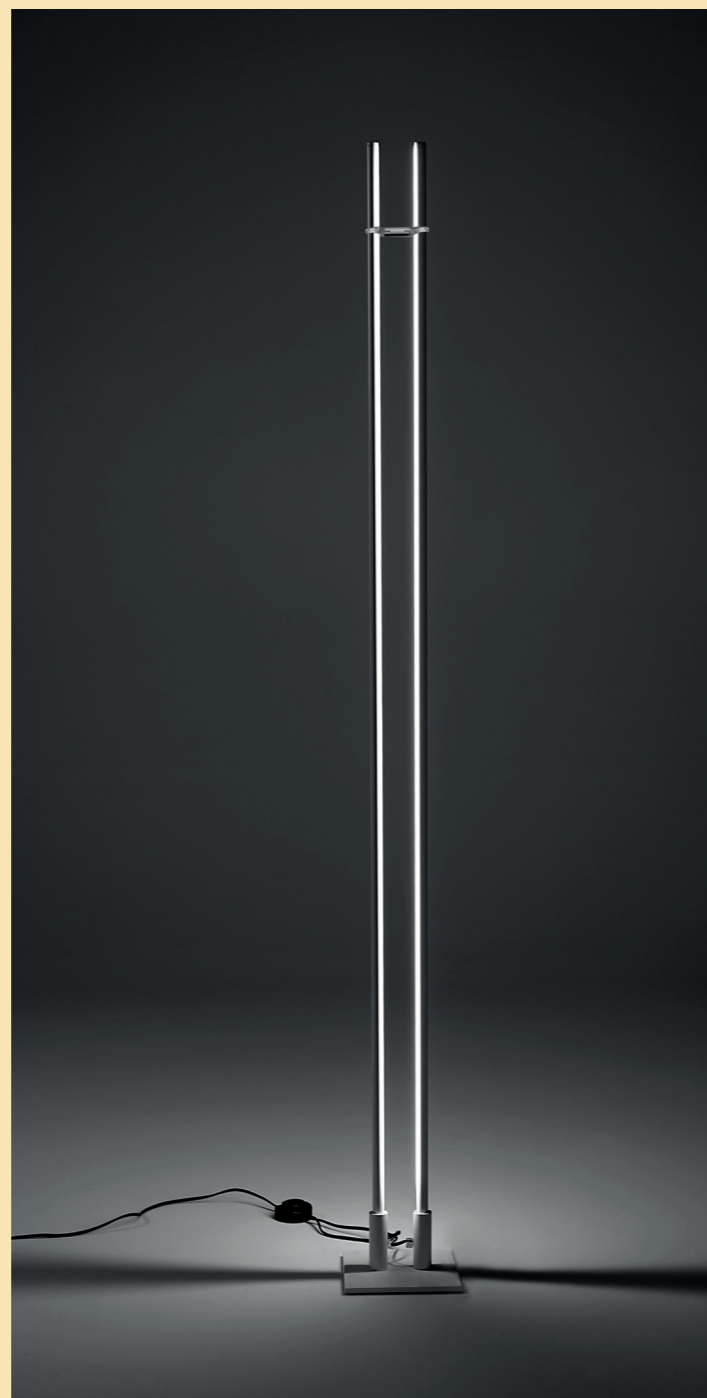

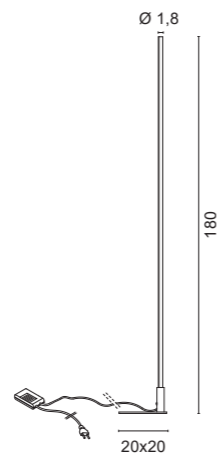

**3522**

- .01 Bianco - White
- .02 Nero - Black

Completa di DIMMER su cavo nero  
With DIMMER on black cable

Color temperature	Light sources	lm
<b>/W</b> 4000K	LED 31,5W CRI>90	3955lm
<b>/WW</b> 3000K	LED 31,5W CRI>90	3535lm
<b>/XW</b> 2700K	LED 31,5W CRI>90	3308lm

2,50 Kg

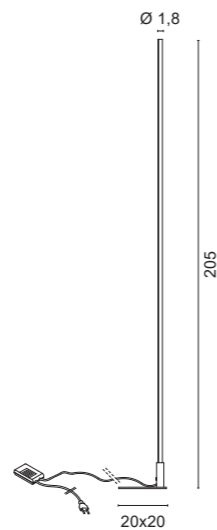

**3523**

- .01 Bianco - White
- .02 Nero - Black

Completa di DIMMER su cavo nero  
With DIMMER on black cable

Color temperature	Light sources	lm
<b>/W</b> 4000K	LED 36W CRI>90	4520lm
<b>/WW</b> 3000K	LED 36W CRI>90	4040lm
<b>/XW</b> 2700K	LED 36W CRI>90	3780lm

2,50 Kg

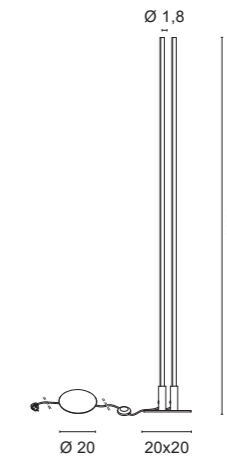
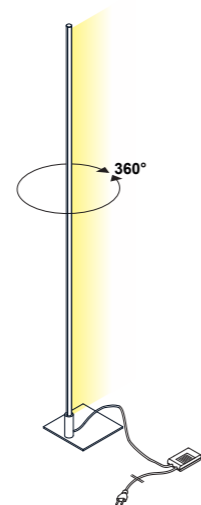

**3524**

- .01 Bianco - White
- .02 Nero - Black

Completa di DIMMER su cavo nero  
With DIMMER on black cable

Color temperature	Light sources	lm
<b>/W</b> 4000K	LED 52,5W CRI>90	6400lm
<b>/WW</b> 3000K	LED 52,5W CRI>90	5770lm
<b>/XW</b> 2700K	LED 52,5W CRI>90	5460lm

4,00 Kg

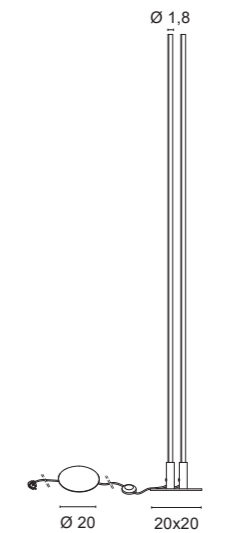

**3525**

- .01 Bianco - White
- .02 Nero - Black

Completa di DIMMER su cavo nero  
With DIMMER on black cable

Color temperature	Light sources	lm
<b>/W</b> 4000K	LED 60W CRI>90	7360lm
<b>/WW</b> 3000K	LED 60W CRI>90	6600lm
<b>/XW</b> 2700K	LED 60W CRI>90	6240lm

4,00 Kg

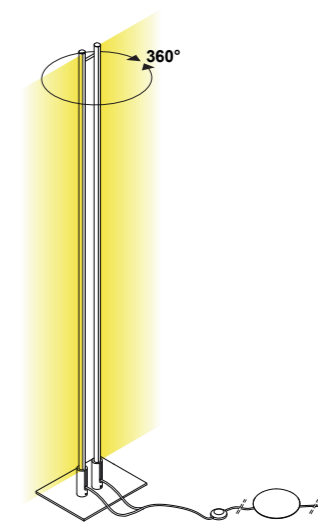



La lampada è fornita con dimmer touch integrato nel profilo.  
The lamp is supplied with a touch dimmer integrated in the profile.

**2506**

- .01** Bianco - White
- .02** Nero - Black

Completa di PUSH DIMMER  
With PUSH DIMMER

	Color temperature	Light sources	lm
<b>/W</b>	4000K	LED 9W CRI>90	1190lm
<b>/WW</b>	3000K	LED 9W CRI>90	1010lm
<b>/XW</b>	2700K	LED 9W CRI>90	945lm

2.20 Kg

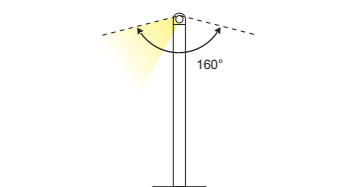
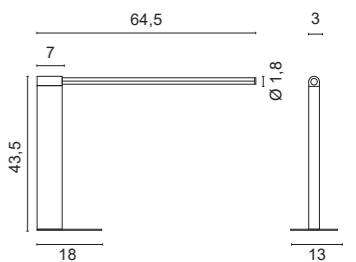



design P. Pepere - 2015

Lampade da Soffitto e da Parete (orientabile) realizzate con un profilo di alluminio e un diffusore in policarbonato opalino.

La versione a parete dal disegno semplice ed essenziale è studiata per l'installazione su specchi o su quadri grazie all'alta efficienza luminosa ed al CRI>90. Disponibile in diverse misure e svariate finiture.

La linea elegante le conferisce un aspetto che ben si adatta a qualsiasi ambiente, dagli interni classici a quelli moderni. La collezione Lancia si completa con le versioni da appoggio (pg. 230), e a sospensione (pg. 98).

*Ceiling and Wall Lamps (adjustable) made with aluminum profile and an opal polycarbonate diffuser.*

*The wall version with a simple and essential design is suitable for installation on mirrors or pictures thanks to the high luminous efficiency and CRI> 90. Available in different sizes and various finishes.*

*The elegant design makes the product suitable for any environment, either classic or modern interiors. The Lancia collection is completed with table/floor (pg. 230) and pendant (pg. 98) application.*

*Plafonniers et Appliques (réglables) réalisés avec un profil en aluminium et un diffuseur en polycarbonate opale.*

*La version applique au design simple et essentiel est étudié pour une installation sur des miroirs ou des tableaux grâce à la haute efficacité lumineuse et CRI> 90. Disponible en différentes dimensions et différentes finitions. La ligne élégante donne un aspect qui s'adapte bien à tout type d'environnement, des intérieurs classiques aux intérieurs modernes. La collection Lancia est complétée par les versions table au sol (p. 230) et suspension (p. 98).*

*Lámparas de techo y pared (orientables) realizadas con perfil de aluminio y difusor de policarbonato opal.*

*La versión de pared con un diseño simple y esencial está diseñada para instalación sobre espejos o cuadros gracias a la alta eficiencia luminosa y CRI> 90. Disponible en diferentes tamaños y varios acabados. La línea elegante le da un aspecto que se adapta bien a cualquier entorno, desde interiores clásicos hasta modernos. La colección Lancia se completa con las versiones sobre mesa y piso (pág. 230) y suspensión (pág. 98).*

*Decken- und Wandleuchten (verstellbar) aus Aluminiumprofil und einem opalen Polycarbonat-Diffusor. Die Wandversion mit schlichtem und essentiell Design eignet sich dank der hohen Lichtausbeute und CRI > 90 für die Montage auf Spiegeln oder Bildern. Erhältlich in verschiedenen Größen und verschiedenen Ausführungen. Durch das elegante Design eignet sich das Produkt für jede Umgebung, sowohl für klassische als auch für moderne Innenräume. Die Lancia-Kollektion wird mit Tisch-/Boden- (S. 230) und Pendel- (S. 98) Applikationen vervollständigt.*

*Р Потолочные и настенные светильники (регулируемые) из алюминиевого профиля и диффузора из опалового поликарбоната. Настенная версия с простым и строгим дизайном подходит для установки на зеркала или картины благодаря высокой светоотдаче и CRI> 90. Доступны в разных размерах и с различной отделкой. Элегантный дизайн делает продукт подходящим для любого интерьера, будь то классический или современный интерьер. Коллекция Lancia дополнена настольной/напольной (стр. 230) и подвеской (стр. 98) Аппликациями.*

# Lancia

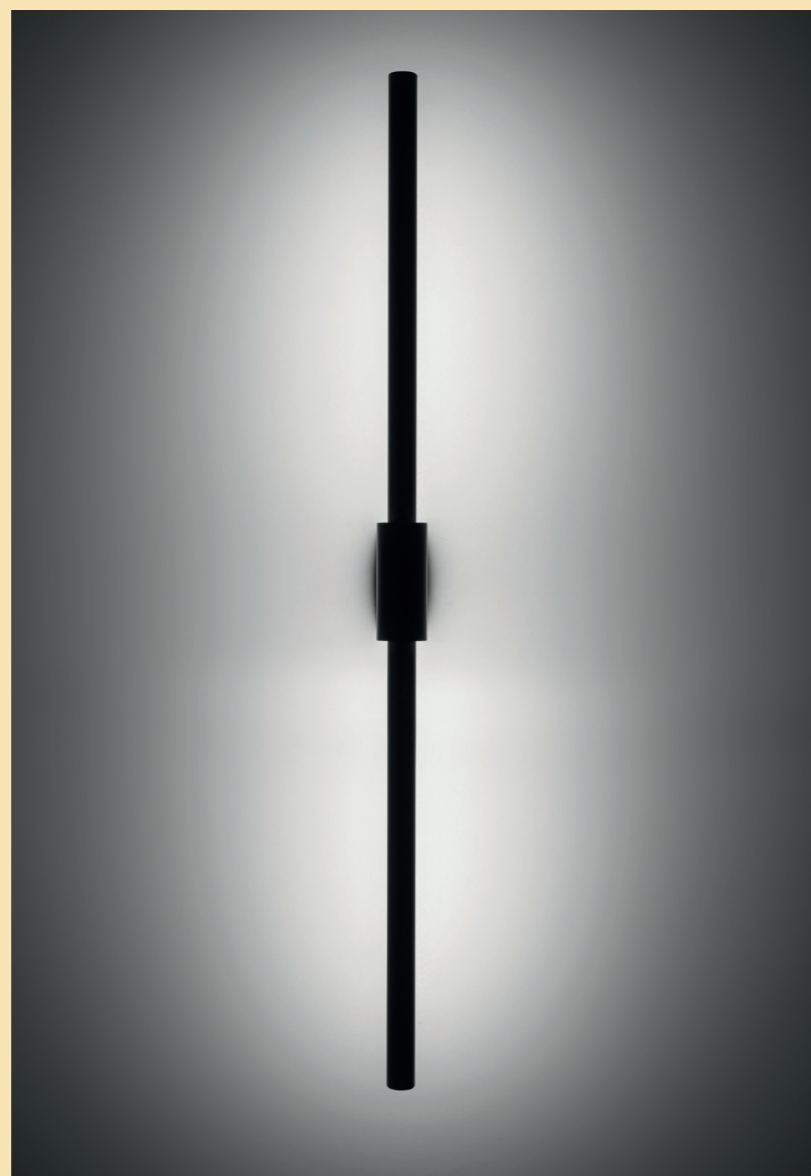
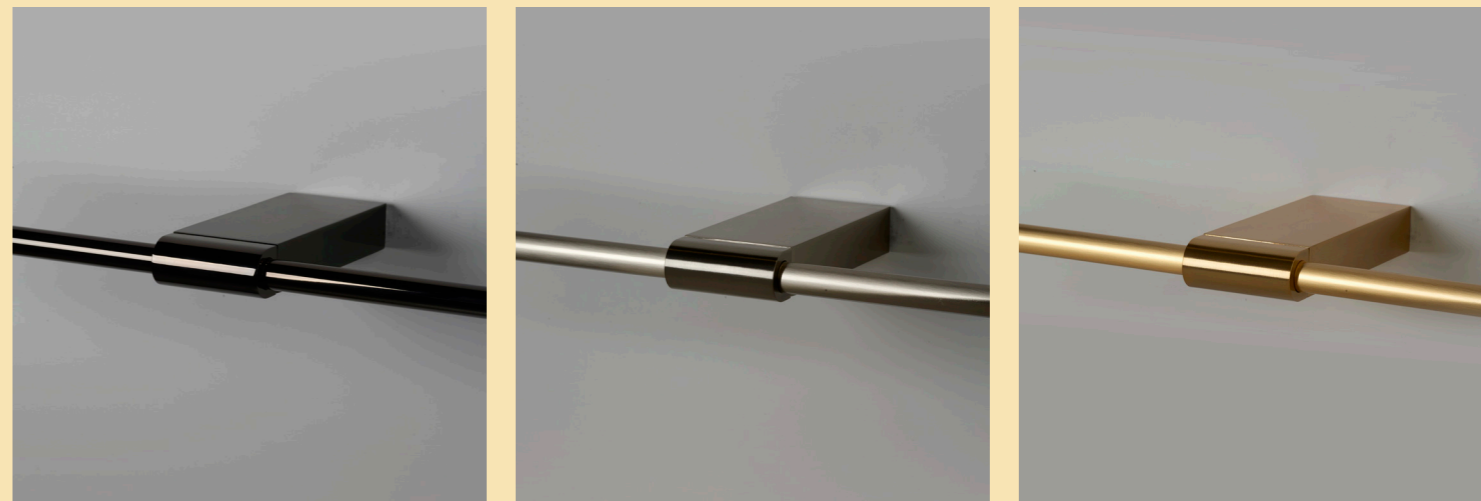



**4567**

<b>.01</b>	Bianco - White
<b>.02</b>	Nero - Black
<b>.24</b>	Cromo nero - Black chrome
<b>.25</b>	Dorato satinato - Golded satin
<b>.31</b>	Cromato lucido - Cromed
<b>.32</b>	Nickel satinato - Nickel mat

Color temperature	Light sources	lm
<b>/W</b> 4000K	LED 9W CRI>90	1130lm
<b>/WW</b> 3000K	LED 9W CRI>90	1010lm
<b>/XW</b> 2700K	LED 9W CRI>90	945lm

	0,80 Kg
--	---------

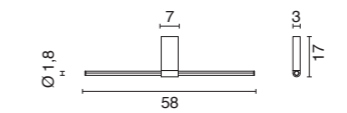

**4568**

<b>.01</b>	Bianco - White
<b>.02</b>	Nero - Black
<b>.24</b>	Cromo nero - Black chrome
<b>.25</b>	Dorato satinato - Golded satin
<b>.31</b>	Cromato lucido - Cromed
<b>.32</b>	Nickel satinato - Nickel mat

Color temperature	Light sources	lm
<b>/W</b> 4000K	LED 18W CRI>90	2260lm
<b>/WW</b> 3000K	LED 18W CRI>90	2020lm
<b>/XW</b> 2700K	LED 18W CRI>90	1890lm

	1,00 Kg
--	---------

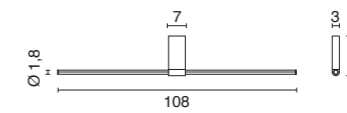

**4569**

<b>.01</b>	Bianco - White
<b>.02</b>	Nero - Black
<b>.24</b>	Cromo nero - Black chrome
<b>.25</b>	Dorato satinato - Golded satin
<b>.31</b>	Cromato lucido - Cromed
<b>.32</b>	Nickel satinato - Nickel mat

Color temperature	Light sources	lm
<b>/W</b> 4000K	LED 16,5W CRI>90	2072lm
<b>/WW</b> 3000K	LED 16,5W CRI>90	1852lm
<b>/XW</b> 2700K	LED 16,5W CRI>90	1732lm

	0,90 Kg
--	---------

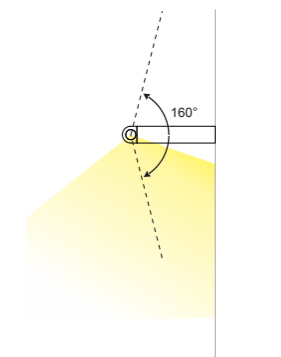
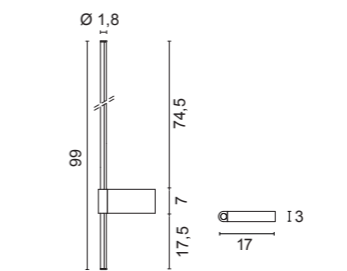

Art. 4567  
Art. 4568  
Art. 4569

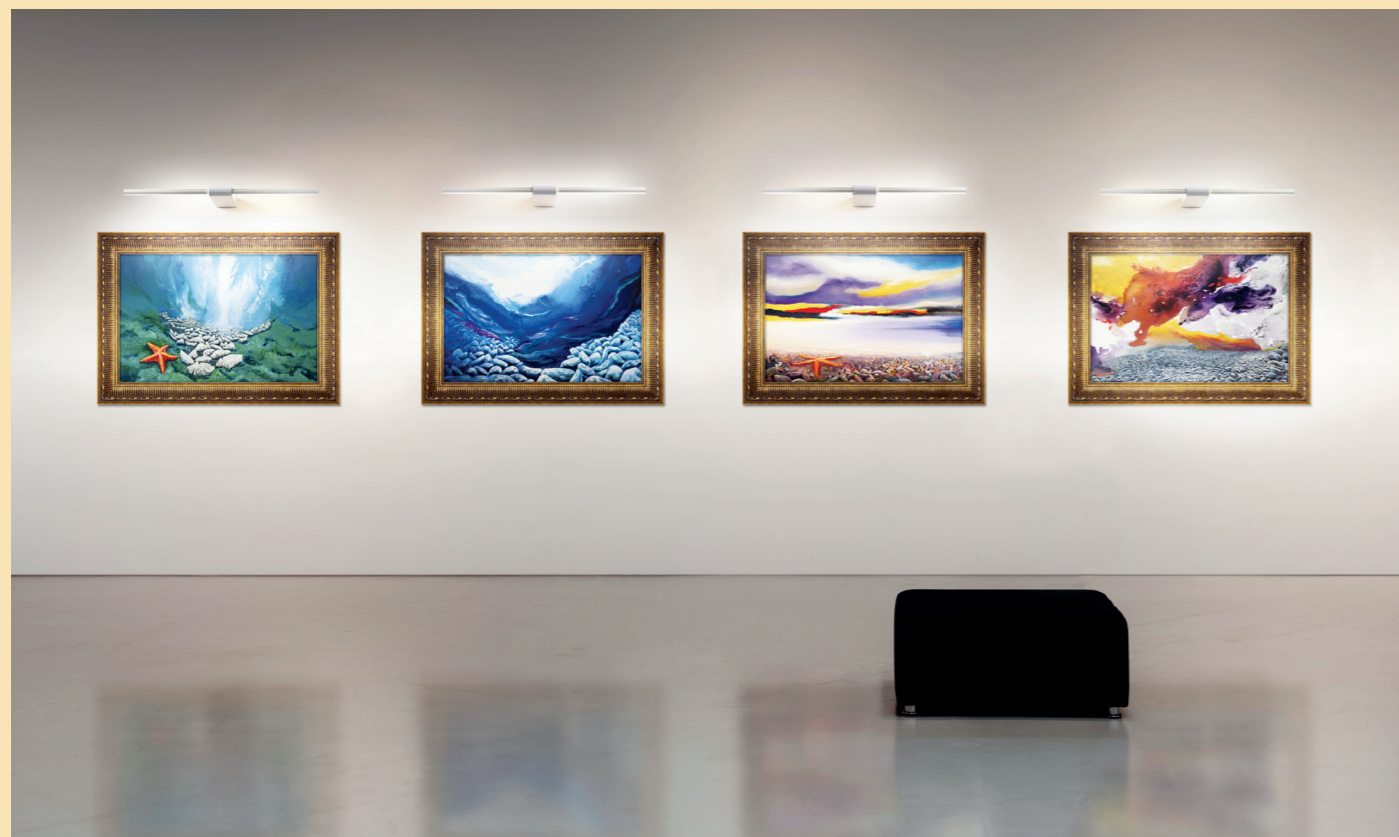

Codici finiture - Finishes codes

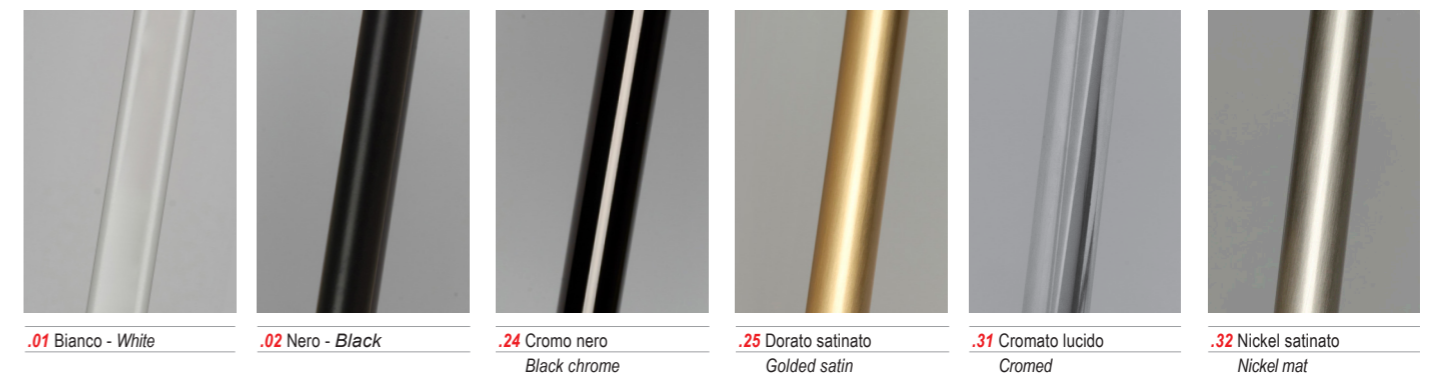

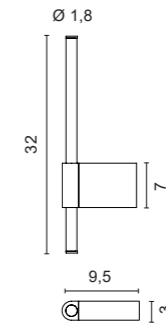
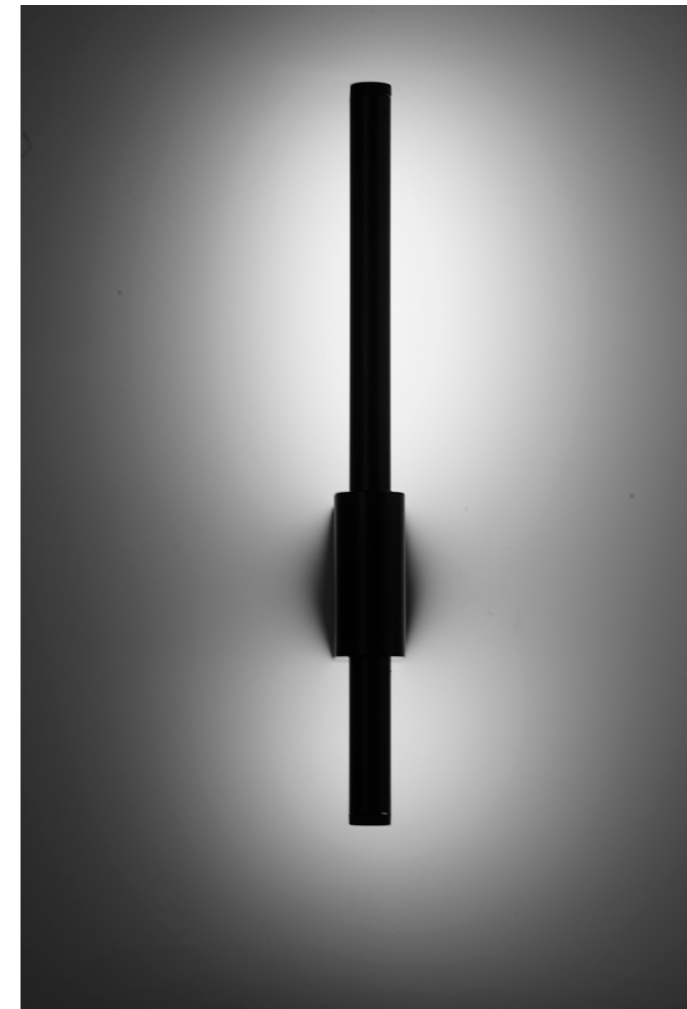

**4566**

- .01** Bianco - White
- .02** Nero - Black
- .25** Dorato satinato - Golded satin

Color temperature	Light sources	lm
<b>W</b> 4000K	LED 5,4W CRI>90	600lm
<b>WW</b> 3000K	LED 5,4W CRI>90	595lm
<b>XW</b> 2700K	LED 5,4W CRI>90	537lm

0,40 Kg

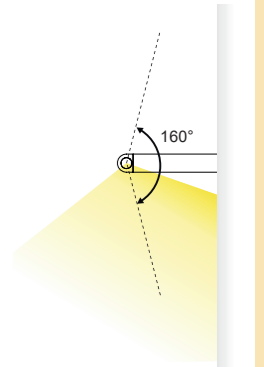

Codici finiture - Finishes codes



**.01** Bianco - White

**.02** Nero - Black

**.25** Dorato satinato  
Golded satin



Diffusore non orientabile. - Diffuser not orientable.

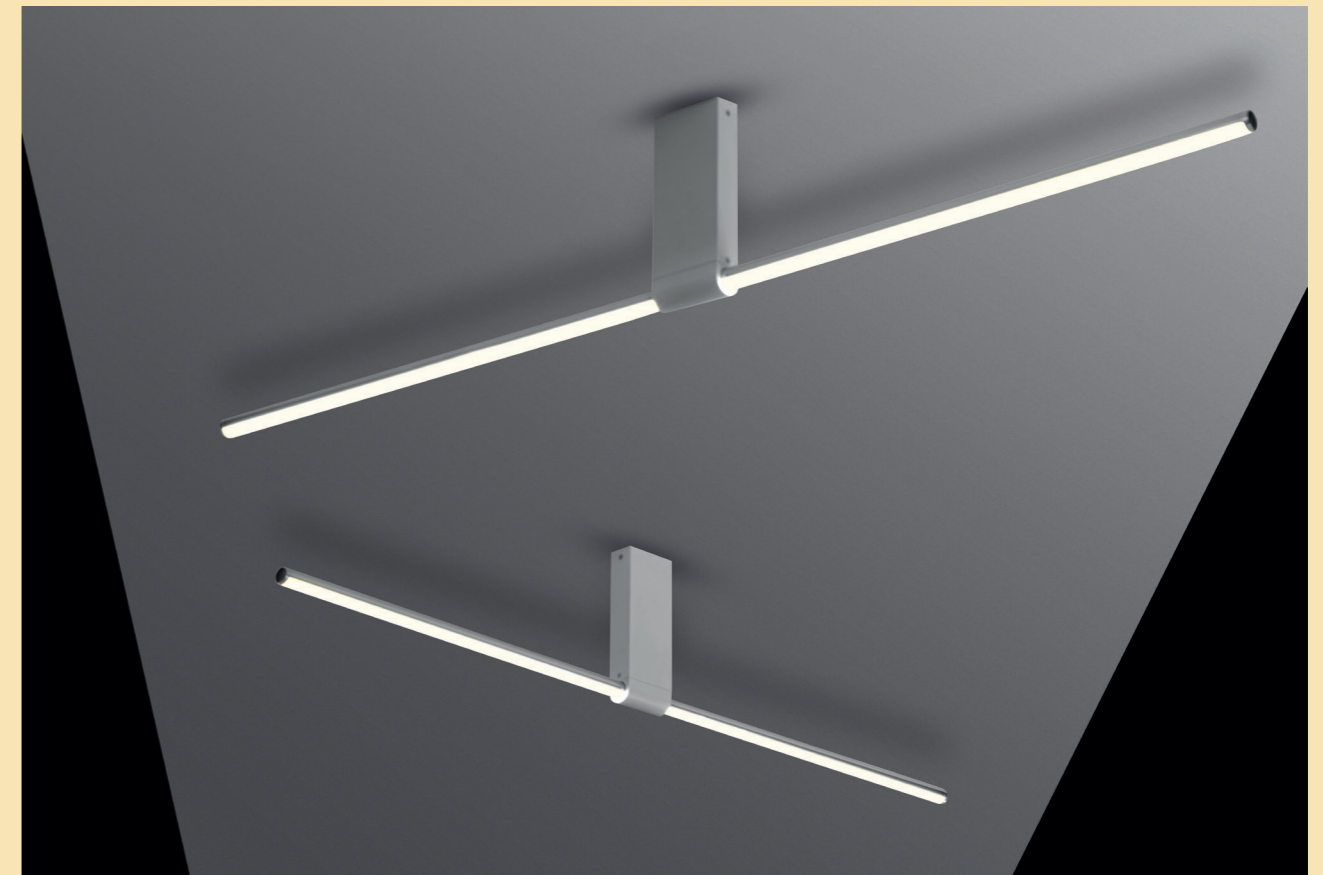

Solo lampada da soffitto, diffusore non orientabile. - Only ceiling lamp, diffuser not orientable.

**4570**

<b>.01</b>	Bianco - White
<b>.02</b>	Nero - Black

Color temperature	Light sources	lm
<b>/W</b> 4000K	LED 22,5W CRI>90	2825lm
<b>/WW</b> 3000K	LED 22,5W CRI>90	2525lm
<b>/XW</b> 2700K	LED 22,5W CRI>90	2362lm

				1,10 Kg
--	--	--	--	---------

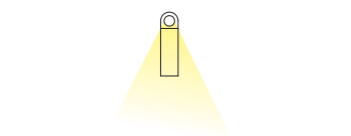
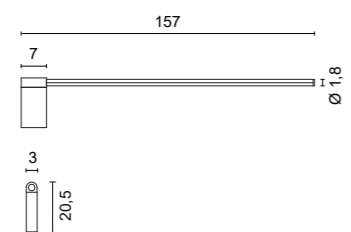

**5567**

<b>.01</b>	Bianco - White
<b>.02</b>	Nero - Black
<b>.31</b>	Cromato - Chromed

Color temperature	Light sources	lm
<b>/W</b> 4000K	LED 9W CRI>90	1130lm
<b>/WW</b> 3000K	LED 9W CRI>90	1010lm
<b>/XW</b> 2700K	LED 9W CRI>90	945lm

				0,80 Kg
--	--	--	--	---------

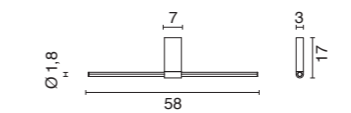

**5568**

<b>.01</b>	Bianco - White
<b>.02</b>	Nero - Black
<b>.31</b>	Cromato - Chromed

Color temperature	Light sources	lm
<b>/W</b> 4000K	LED 18W CRI>90	2260lm
<b>/WW</b> 3000K	LED 18W CRI>90	2020lm
<b>/XW</b> 2700K	LED 18W CRI>90	1980lm

				0,80 Kg
--	--	--	--	---------

